

# Alarm clock

Classic, Pro & Visit model



Wecker

Väckarklocka

Despertador

 Bellman & Symfon®

# Connections | Anschlüsse | Anslutningar | Conecciones

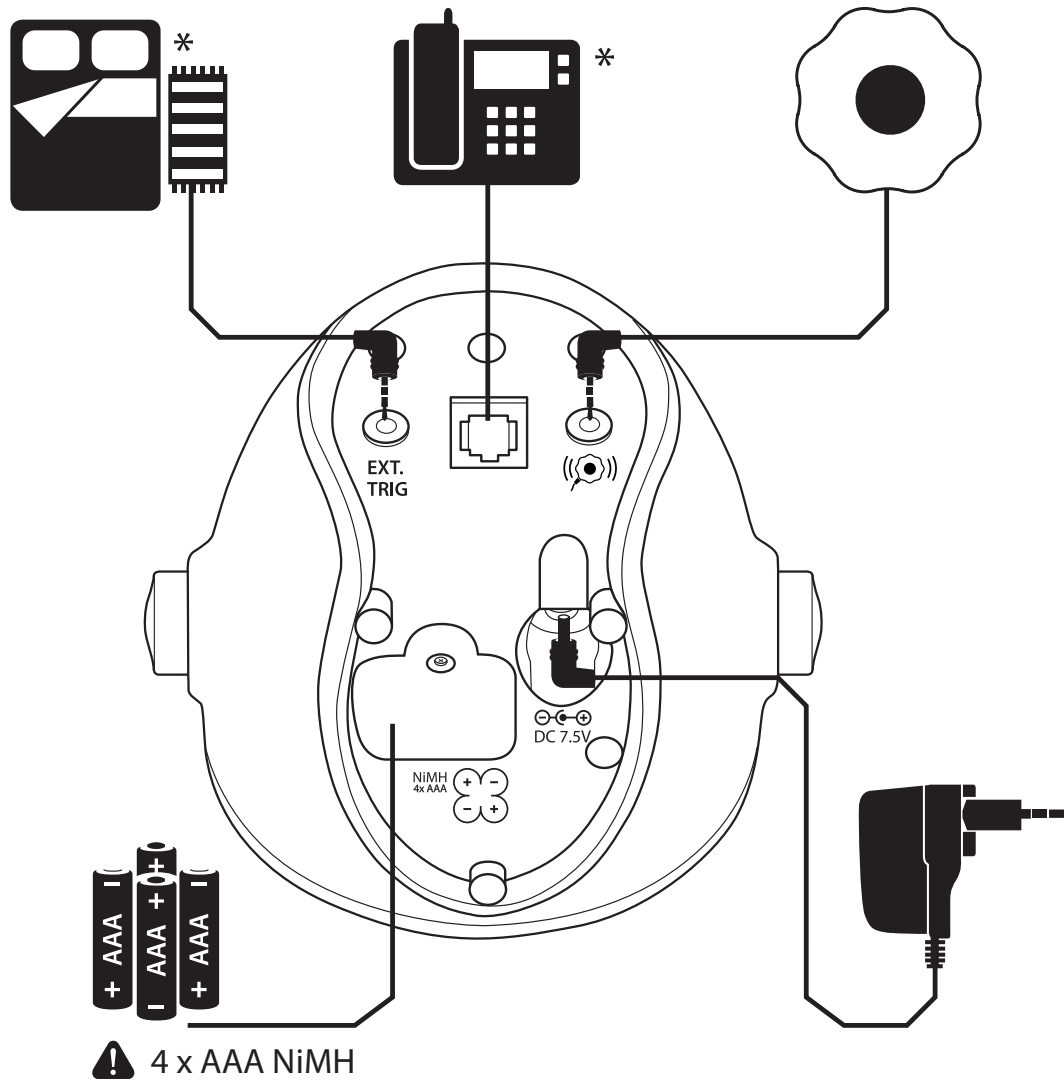

\* Pro & Visit model

1-2 Time | Zeit  
Tid | Hora

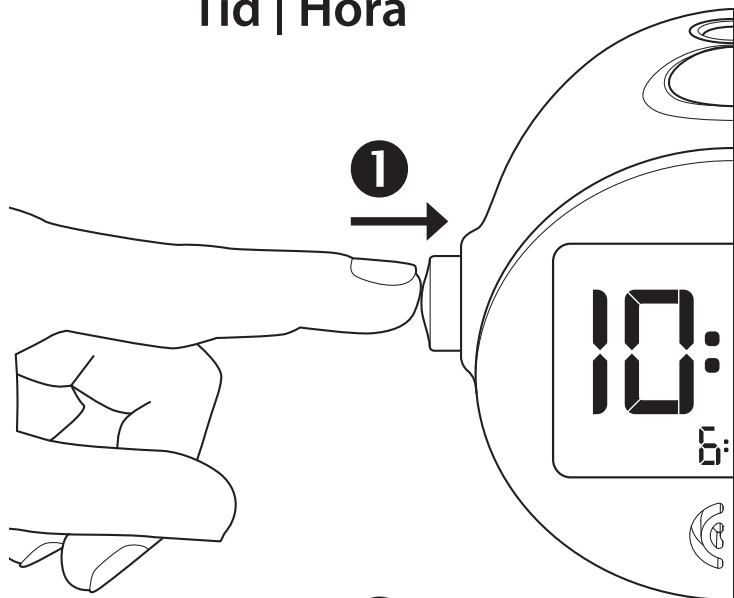

2

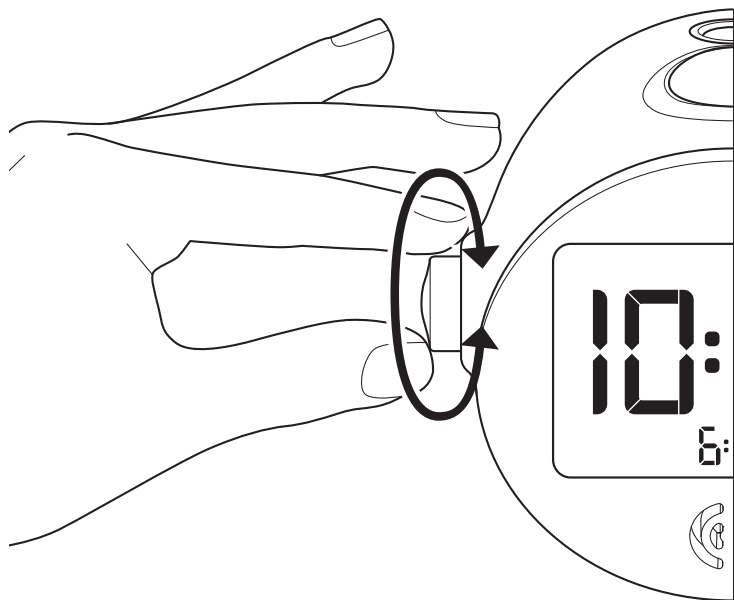

A-B Alarm | Alarm  
Alarm | Alarma

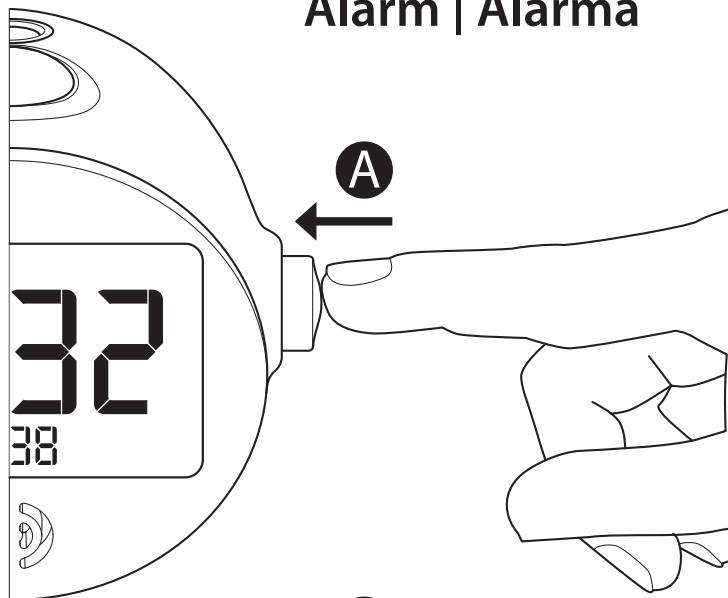

B

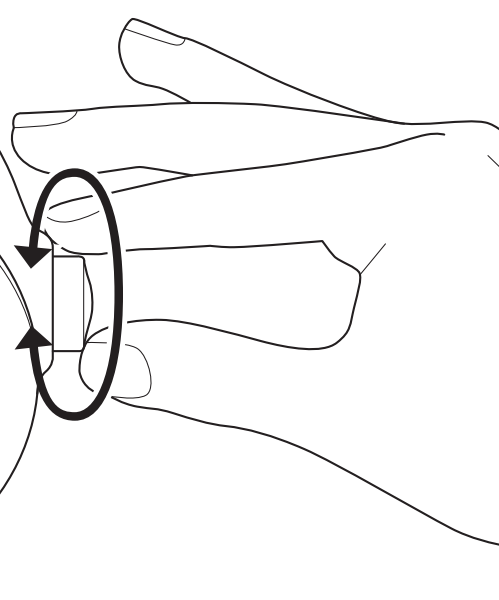

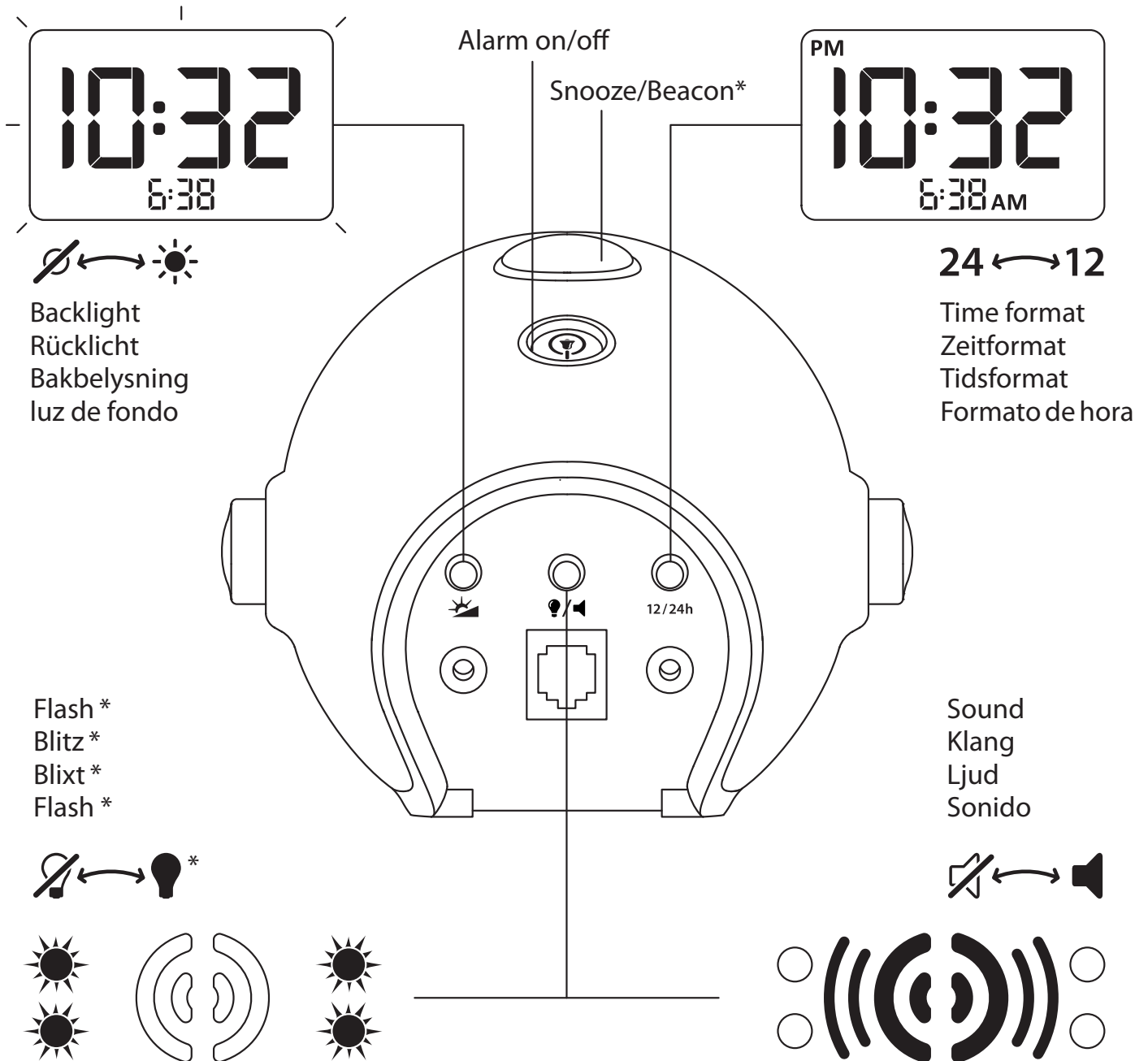

Alarm on/off

Snooze/Beacon\*

PM

10:32

6:38

10:32

6:38 AM



Backlight  
Rücklicht  
Bakbelysning  
luz de fondo

24 ↔ 12

Time format  
Zeitformat  
Tidsformat  
Formato de hora

Flash \*  
Blitz \*  
Blixt \*  
Flash \*



Sound  
Klang  
Ljud  
Sonido



\* Pro & Visit model

## Visit model



Connects to the Bellman Visit-system  
Anschluss an den Bellman Visit-System  
Använd som en mottagare i Bellman Visitsystemet  
Se conecta al sistema Bellman Visit

Visit Pairing  
Visit Paarung  
Visit Parning  
Emparejamiento

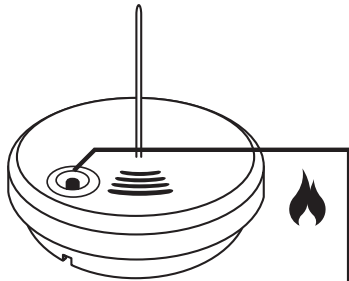

Fire  
Feuer  
Eld  
Fuego

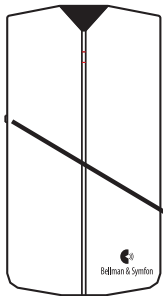

Door  
Tür  
Dörr  
Puerta

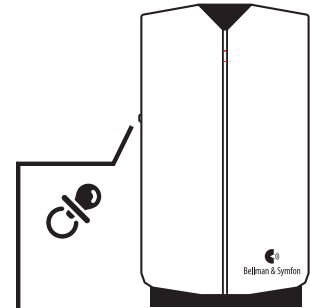
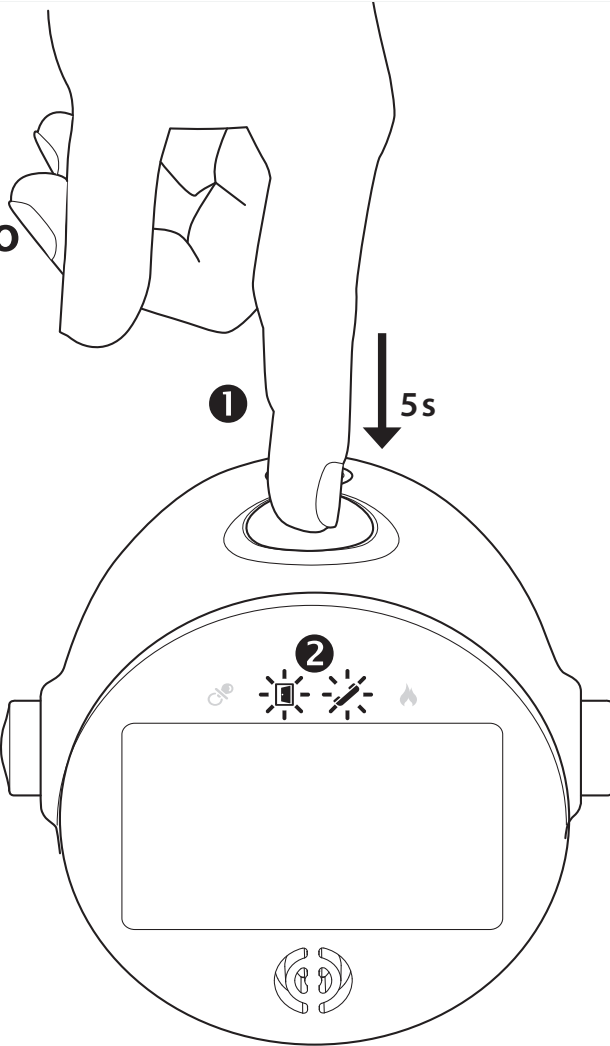

Baby  
Baby  
Baby  
Bebé

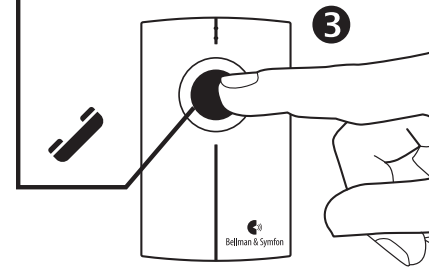

Telephone  
Telefon  
Telefon  
Teléfono



### For use in all EU countries

Hereby, Bellman & Symfon AB, declares that this Alarm Clock is in compliance with the essential requirements and other relevant provisions of directives: R&TTE 1999/5/EC, LVD 1973/23/EC, EMC 1989/336/EC, MDD 1993/42/EEC.

Correct use and disposal of batteries:

Replace only with the same or equivalent type recommended by the manufacturer. Please dispose of old, defective batteries in an environmentally friendly manner in accordance with the relevant legislation.

### FCC compliance statement

This device complies with Part 15 of the FCC Rules. Operation is subject to the following two conditions: (1) this device may not cause harmful interference, and (2) this device must accept any interference received, including interference that may cause undesired operation.

 **Warning:** Changes or modifications to this unit not expressly approved by the party responsible for compliance could void the user's authority to operate the equipment.

 **Note:** This equipment has been tested and found to comply with the limits for a Class B digital device, pursuant to Part 15 of the FCC Rules. These limits are designed to provide reasonable protection against harmful interference in a residential installation. This equipment generates, uses and can radiate radio frequency energy and, if not installed and used in accordance with the instructions, may cause harmful interference to radio communications. However, there is no guarantee that interference will not occur in a particular installation. If this equipment does cause harmful interference to radio or television reception, which can be determined by turning the equipment off and on, the user is encouraged to try to correct the

interference by one or more of the following measures:

- Reorient or relocate the receiving antenna.
- Increase the separation between the equipment and receiver.
- Connect the equipment into an outlet on a circuit different from that to which the receiver is connected.
- Consult the dealer or an experienced radio/TV technician for help.

### Statement for Industry Canada

Le fonctionnement de cet équipement est soumis aux conditions suivantes:

 (1) l'équipement concerné ne doit pas causer d'interférences, et (2) il doit accepter toute interférence reçue, y compris les interférences risquant d'engendrer un fonctionnement indésirable.

Cet appareil numérique de la classe B est conforme à la norme NMB-003 du Canada.

This Class B digital apparatus complies with Canadian ICES-003.

## Available in the following models

Visit	BE1380, 433.9 MHz
	BE1580, 868.3 MHz
	BE1580-315, 314.9 MHz
Pro	BE1370
Classic	BE1350

BE1580\_067MAN001\_EN

### European Office

Bellman & Symfon Europe AB  
Södra Långebergsgatan 30  
421 32 Västra Frölunda  
Sweden  
Phone +46 31 68 28 20  
Fax +46 31 68 28 90  
E-mail [info@bellman.se](mailto:info@bellman.se)  
[www.bellman.com](http://www.bellman.com)

### Asia Pacific Office

Bellman & Symfon Asia Ltd.  
1115-16 , Main Tower, GD Int'l Hotel  
339 Huanshi Dong Rd  
Guangzhou, China, 510095  
Phone +86 20 8318 2950  
Fax +86 20 8333 5528  
E-mail [info.cn@bellman.com](mailto:info.cn@bellman.com)  
[www.bellman.cn](http://www.bellman.cn)