

1 Description

Aube's TH115 programmable thermostats have three temperature control modes:

- A mode:** ▶ controls the ambient air temperature
- F mode:** ▶ controls the floor temperature using an external temperature sensor
- AF mode:**
 - ▶ controls the ambient air temperature
 - ▶ maintains the floor temperature within desired limits using an external temperature sensor

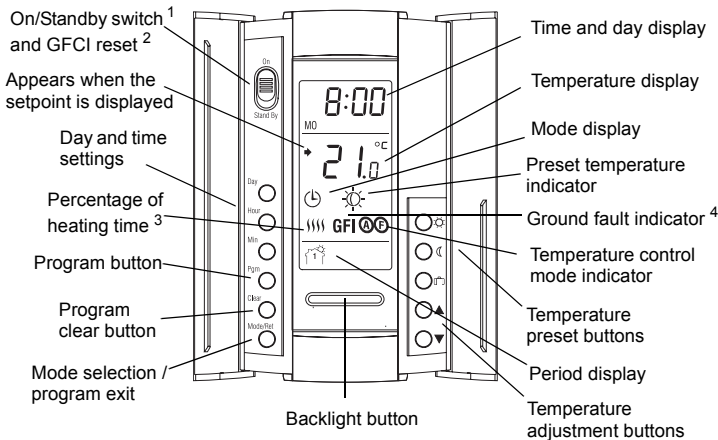

¹ Place the switch in Standby to cut power to the heater when not in use (e.g., in the summer). This will not affect the time and temperature settings.

² If your thermostat is installed on a power base equipped with a ground fault protection, to reset the ground fault protection, switch the thermostat to Standby and back to On.

³ The thermostat displays the percentage of heating time required to maintain the desired temperature. For example, 40 is displayed when heating is activated 40 percent of the time.

Display	1	2	3	4	5
% of heating time	1 to 24%	25 to 49%	50 to 74%	75 to 99%	100%

⁴ GFI appears when the ground fault protection has tripped.

2 Configuration

Some thermostat configurations can be modified via switches on the back of the faceplate (control module).

Default (factory) settings are inside the gray cells.

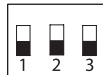

#	Configurations	UP	DN
1	Display format	°F / 12 h	°C / 24 h
2	Early Start ^a	Enable	Disable
3	Temperature control mode ^b	F	AF

a. Early Start can be used in Automatic mode only. When this function is enabled, the thermostat calculates the optimal time to start heating in order to obtain the desired temperature by the set time. The thermostat re-assesses the start time daily based on the previous day's results.

b. To select the F mode, place the switch in the F position. To select the AF mode, place the switch in the AF position and ensure that the remote temperature sensor is connected to the thermostat. To select the A mode, place the switch in the A position and ensure that the remote temperature sensor is **NOT** connected to the thermostat.

3 Installation

- 1 Refer to the installation instructions of the power base.
- 2 Insert the tabs at the top of the control module in the slots at the top of the power base.
- 3 Secure the control module using the captive screw underneath the base.

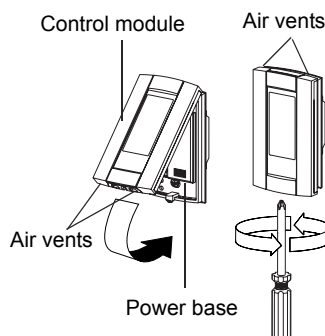

NOTE: Keep the thermostat's air vents clean and unobstructed at all times.

4 Clock and Day Setting

- 1 Press the **Hour** button to set the hour.
- 2 Set the **Min** button to set the minutes.
- 3 Set the **Day** button to set the day.
- 4 Press **Mode/Ret** to exit.

Daylight Savings Time

The thermostat can automatically re-adjust its clock at Daylight Savings Time changeover. When this function is enabled (On), the thermostat switches to Daylight Savings Time on the second Sunday of March and to normal time on the first Sunday of November.

NOTE: The function is disabled (default setting) when the clock loses its setting.

- 1 Press the **Day** button (3 seconds) until **DLS** appears on the screen.
- 2 Press the ▲▼ to toggle between On (enabled) and Off (disabled).
- 3 Press the **Day** button briefly. The year setting is displayed.
- 4 Press the ▲▼ to set the current year.
- 5 Press the **Day** button briefly. The month setting is displayed.
- 6 Press the ▲▼ to set the current month.
- 7 Press the **Day** button briefly. The date setting is displayed.
- 8 Press the ▲▼ to set the current date.
- 9 Press **Mode/Ret** to exit.

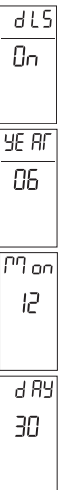

5 Backlight

The display illuminates for 12 seconds when the backlight button is pressed.

When either of the ▲▼ buttons is pressed, the display also illuminates for 12 seconds. The setpoint temperature appears for 5 seconds, then the actual (measured) temperature is displayed.

6 Temperature Adjustment

6.1 Setpoint Temperature

The thermostat normally displays the actual (measured) temperature. To view the setpoint, press one of the ▲▼ buttons once. The setpoint will appear for the next 5 seconds.

To change the setpoint, press one of the ▲▼ buttons until the desired temperature is displayed. To scroll faster, press and hold the button.

6.2 Preset Temperatures

The thermostat has 3 preset temperatures:

- ▶ Comfort temperature ☀
- ▶ Economy temperature ☾
- ▶ Vacation temperature ☑

To use a preset temperature, press the corresponding button. The corresponding icon ☀, ☾ or ☑ will be displayed.

The following table shows the intended use and the default setting of each of the preset temperatures.

Icon	Intended use	A/AF modes	F mode
☀	Comfort (when at home)	21 °C (70 °F)	28 °C (82 °F)
☾	Economy (when asleep or away from home)	17 °C (63 °F)	20 °C (68 °F)
☑	Vacation (during prolonged absence)	10 °C (50 °F)	10 °C (50 °F)







To store a preset temperature:

- 1 Set the desired temperature using the ▲▼ buttons.
- 2 Press and hold the corresponding button until the corresponding icon is displayed.

6.3 Floor Temperature Limits (AF mode only)

NOTE: To avoid damaging your floor, follow your floor supplier's recommendations regarding floor temperature limits.

The minimum and maximum floor temperature limits are 5 °C (41 °F) and 28 °C (82 °F) by default. To modify these limits, proceed as follows:

- 1 Switch the thermostat to Standby.
- 2 Press and hold the  button.
- 3 Switch the thermostat back to On.
- 4 Release the  button when the minimum temperature limit (FL:LO) appears.
- 5 Set the minimum temperature limit using the   buttons.
- 6 Press the  button to display the maximum temperature limit (FL:HI).
- 7 Set the maximum temperature limit using the   buttons.
- 8 Press **Mode/Ret** to exit.

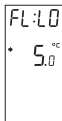





7 Modes of Operation

The thermostat has 3 modes of operation.

7.1 Automatic Mode









The thermostat follows the programmed schedule. To place the thermostat in this mode, press **Mode/Ret** until  is displayed. The data of the current schedule period are also displayed.





Temporary Bypass

If you modify the setpoint temperature (by pressing the ,  or  button) when the thermostat is in automatic mode, the new temperature will be used until the beginning of the next period.  flashes during the bypass. You can cancel the bypass by pressing **Mode/Ret**.

Programmed Schedule

The schedule consists of 4 periods per day which represents a typical week day. You can program the thermostat to skip the periods that do not apply to your situation. For example, you can skip periods 2 and 3 for the weekend.

Period	Description	Associated temperature setting
	Wake-up	
	Away from home	
	Return home	
	Sleep	

The Comfort () temperature is used in periods 1 and 3 and the Economy () temperature is used in periods 2 and 4. For example, when the period changes from 1 to 2, the setpoint automatically changes from Comfort () temperature to Economy () temperature.

You can have a different program for each day of the week; i.e., each period can start at different time for each day of the week. The thermostat has been programmed with the following schedule.

Period	Setting	MO	TU	WE	TH	FR	SA	SU
		6:00	6:00	6:00	6:00	6:00	6:00	6:00
		8:30	8:30	8:30	8:30	8:30	--:--	--:--
		17:00	17:00	17:00	17:00	17:00	--:--	--:--
		23:00	23:00	23:00	23:00	23:00	23:00	23:00





To modify the schedule:

- 1 Press **Pgm** to access the programming mode. Period 1 is selected.
- 2 Press **Day** to select the day to program (hold for 3 seconds to select the entire week).
- 3 Press **Hour** and **Min** to set the start time of the selected period, or press **Clear** if you want to skip the period (--:-- is displayed).
NOTE: If you intend to use only 2 periods, set periods "1 and 4" or periods "2 and 3". Early Start will not work if you set periods "1 and 2" or periods "3 and 4".
- 4 Press **Pgm** to select another period, or press **Day** to select another day. Then repeat step 3.
- 5 Press **Mode/Ret** to exit the programming mode.

NOTE: If no button is pressed for 60 seconds, the thermostat will automatically exit the programming mode.





7.2 Manual Mode

The programmed schedule is not used. The temperature must be set manually. To place the thermostat in this mode:

- 1 Press **Mode/Ret** until  is displayed.
- 2 Set the temperature using the ,  or  button.

7.3 Vacation Mode

In this mode, the thermostat is set to Vacation temperature. There are two ways to place the thermostat in Vacation mode:

- ▶ By pressing the  button on the thermostat. When the Vacation mode is activated using the  button, the  icon appears on the screen without flashing.
- ▶ From an Aube telephone controller (CT240/CT241) or any other remote control device equipped with a dry contact if your power base is equipped with the ECONO input. When the contact closes, the Vacation mode is activated and the  icon flashes on the screen. All buttons on the thermostat are locked. When the contact opens, the thermostat returns to the preceding mode.

NOTE: When the Vacation mode is activated using a remote control device, it can only be deactivated using the device.

8 Error Messages

- LO The measured temperature is below the thermostat's display range. Heating is activated.
- HI The measured temperature is above the thermostat's display range. Heating is deactivated.
- Er Verify the thermostat and sensor connections.

9 Technical Specifications

Power supply: Refer to the power base's installation guide.

Display range: 0 °C to 70 °C (32 °F to 158 °F)

Ambient setpoint range (A/AF modes): 5 °C to 30 °C (40 °F - 86 °F)

Floor setpoint range (F mode): 5 °C to 40 °C (40 °F - 104 °F)

Floor limit range (AF mode): 5 °C to 40 °C (40 °F - 104 °F)

Display resolution: 0.5 °C (1 °F)

Operating temperature: 0 °C to 50 °C (32 °F to 120 °F)

Storage temperature: -20 °C to 50 °C (-4 °F to 120 °F)

Heating cycle length: Refer to the power base's installation guide

Data backup: In the event of a power failure, most settings are saved.

Only the time must be re-adjusted if the power failure lasts more than 6 hours. The thermostat will return to the mode that was active prior to the power failure.

Warranty

Aube warrants this product, excluding battery, to be free from defects in the workmanship or materials, under normal use and service, for a period of three (3) years from the date of purchase by the consumer. If at any time during the warranty period the product is determined to be defective or malfunctions, Aube shall repair or replace it (at Aube's option).

If the product is defective,

- return it, with a bill of sale or other dated proof of purchase, to the place from which you purchased it, or
- contact Aube. Aube will make the determination whether the product should be returned, or whether a replacement product can be sent to you.

This warranty does not cover removal or reinstallation costs. This warranty shall not apply if it is shown by Aube that the defect or malfunction was caused by damage which occurred while the product was in the possession of a consumer.

Aube's sole responsibility shall be to repair or replace the product within the terms stated above. AUBE SHALL NOT BE LIABLE FOR ANY LOSS OR DAMAGE OF ANY KIND, INCLUDING ANY INCIDENTAL OR CONSEQUENTIAL DAMAGES RESULTING, DIRECTLY OR INDIRECTLY, FROM ANY BREACH OF ANY WARRANTY, EXPRESS OR IMPLIED, OR ANY OTHER FAILURE OF THIS PRODUCT. Some provinces, states or regions do not allow the exclusion or limitation of incidental or consequential damages, so this limitation may not apply to you.

THIS WARRANTY IS THE ONLY EXPRESS WARRANTY AUBE MAKES ON THIS PRODUCT. THE DURATION OF ANY IMPLIED WARRANTIES, INCLUDING THE WARRANTIES OF MERCHANTABILITY AND FITNESS FOR A PARTICULAR PURPOSE, IS HEREBY LIMITED TO THE THREE-YEAR DURATION OF THIS WARRANTY. Some provinces, states or regions do not allow limitations on how long an implied warranty lasts, so the above limitation may not apply to you.

This warranty gives you specific legal rights, and you may have other rights which vary from province, state or region to another.

Customer Assistance

For any questions regarding product installation or operation, contact us at:

705 Montrichard
Saint-Jean-sur-Richelieu, Quebec
J2X 5K8

Canada

Tel.: (450) 358-4600

Toll-free: 1-800-831-AUBE

Fax: (450) 358-4650

E-mail: aube.service@honeywell.com



For more information on our products, visit us at:
www.aubetech.com

1 Parts

- 1 One (1) power base
- 2 Two (2) screws
- 3 Four (4) solderless connectors for copper wires

NOTE: Special CO/ALR solderless connectors must be used for connecting aluminum conductors.

Option

- 4 One (1) AC112-01 floor sensor (ordered separately; required for floor heating applications only)

2 Guidelines

Turn off power to the heating system at the main electrical panel to avoid electrical shock. The installation should be carried out by an electrician.

NOTE: This power base must be used with thermostat operating on 15-minute cycles.

- ▶ High voltage thermostats must be installed onto an electrical box.

The following guidelines are not necessary for floor heating applications:

- ▶ For a new installation, choose a location about 1.5 m (5 ft) above the floor and on an inside wall.
- ▶ The thermostat must be installed on an inside wall facing the heating system.
- ▶ Avoid locations where there are air drafts (top of staircase, air outlet), dead air spots (behind a door), direct sunlight or concealed chimneys or stove pipes.

3 Procedure

- 1 Connect the power base wires to the power supply and load using solderless connectors for copper wires (figure 1).

- 2 For floor heating applications, insert the floor sensor wires through one of the two holes below the terminals (figure 2) and connect the wires to terminals 3 and 4 (no polarity).

NOTE: The wires must run alongside the terminals and not go over them. The wire must not cross any heating wires nor be placed directly on a heating wire or adjacent to it. For best performance, the sensor probe should be centered between the wires in the mat.

WARNING: This power base does not have a built-in ground protection device. Therefore, for floor heating applications, you must install a separate ground protection device at the main electrical panel. Contact your Aube authorized representative if you need a thermostat with built-in ground protection device.

- 3 If you wish to use a remote controller such as the CT240 or CT241, insert the cable (use 18 to 22 gauge flexible wires) into one of the two holes available below the terminal board and connect to terminals 1 and 2 of the base (figure 2).
- 4 Push the excess length of the high-voltage wires back into the electrical box.
- 5 Secure the power base to the electrical box using the provided screws.

- 6 If necessary, set the configuration switches on the control module (refer to the control module user guide).
- 7 Install the control module onto the base.
- 8 Apply power to heating system.

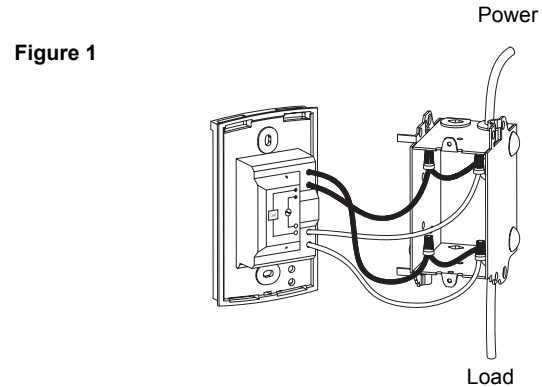

Figure 1

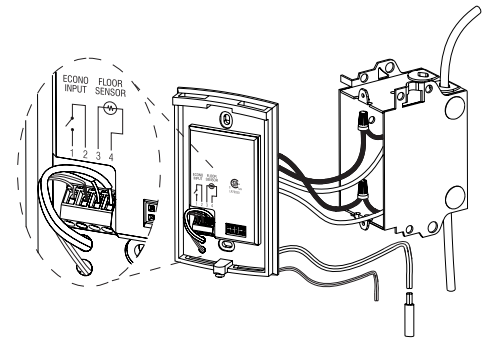

Figure 2

4 Technical Specifications

Model	Supply	Max. Load	Power	Wiring
120S	120 VAC, 50/60Hz	16.7 A	2000 W	4 wires / single pole
240S	240 VAC, 50/60Hz 208 VAC, 50/60Hz	16.7 A	4000 W 3475 W	4 wires / single pole
240D	240 VAC, 50/60Hz 208 VAC, 50/60Hz	15 A	3600 W 3120 W	4 wires / double pole

Storage: -4°F to 120°F (-20°C to 50°C)

Remote controller input (ECONO): requires a dry contact

Size (H • W • D): 4.89 x 2.76 x 0.91 in. (124 x 70 x 23 mm)

Certifications:  